



DECOR SERIES - Ceiling conceal

**Ceiling conceal mounted air Conditioner
Model CFHV / AFV and CFHQ / AFQ**

4 directional autoswing supply air grille design serving wide area with cool fresh air. 4 colors available for your decoration style.

Fan coil Unit



Turbo Fan
Powerful turbo motor helps fill the coolness to the room quickly yet quietly.

■ Model : CFHV



Hydrophilic Coil
Evaporator coils use blue fin coating Easily drain out water droplets, reduce smelly odor, reduce mold, save energy, and more durable than normal fins.



Copper tube
Inner groove copper tube increase heat exchanger surface

■ Model : SGF

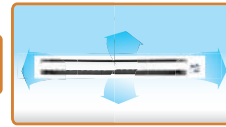

4 Directional airflow
Intelligent airflow system. Auto swing louver for a better air flow, both vertical and horizontal directions.



Fan coil unit and supply air grille installation

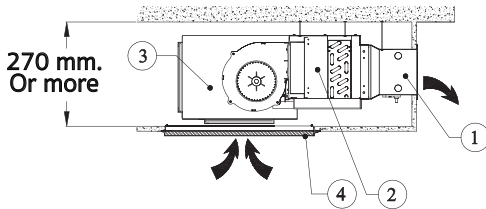

Fan coil unit and supply air grille installation at same level

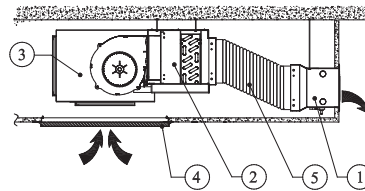

Fan coil unit and supply air grille installation at different level (by additional flexible duct)

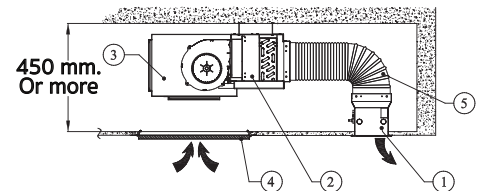

1. Supply air grille model SGF with hood
2. Fan coil unit model CFHV
3. Return plenum
4. Return air grille model RAGV
5. Flexible duct (with instant installation set)

Supply air grille model SGF with HOOD

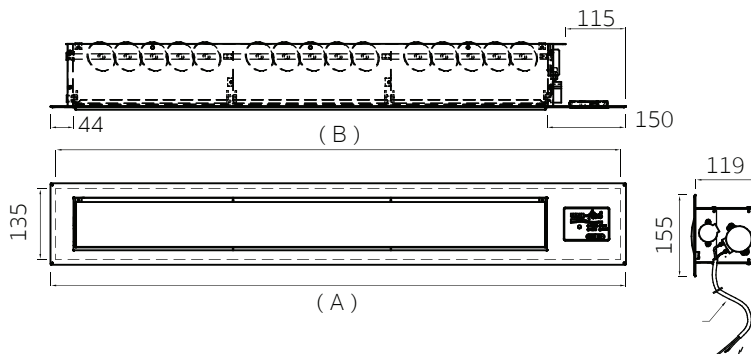

MODEL	For model	A(mm.)	B(mm.)
SGF-01 (8"×35")	CFHV-13FS	1,096	1,076
SGF-02 (8"×41")	CFHV-18FS	1,396	1,376
SGF-02 (8"×46-1/4")	CFHV-25F		
SGF-02 (10"×41")	CFHV-30F		
SGF-02 (10"×46-1/4")	CFHV-36F	1,696	1,676
SGF-03 (10"×57-5/8")	CFHV-40F		
	CFHQ-50F		
	CFHQ-60F		

Return air grille model RAGV

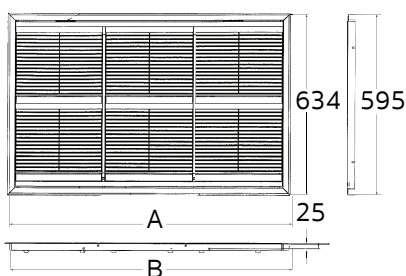

Easy to clean and service through removable return air grille and filter

MODEL	For model	A(mm.)	B(mm.)
RAGV-01	CFHV-13FS	997	971
RAGV-02	CFHV-18FS	1,288	1,282
	CFHV-25F		
	CFHV-30F		
RAGV-03	CFHV-36F	1,599	1,593
	CFHV-40F		
	CFHQ-50F		
	CFHQ-60F		

Thermostat



optional

Digital wired thermostat

Modern-designed, easy-to-use digital wired thermostat with LCD display. Can be used as a control signal receiver from wireless remote controller

optional

Wireless digital thermostat

4 Speed Motor
4 speeds adjustable wind blow
Turbo - High - Medium - Low
For Turbo cool or Quiet cool.

ECO Mode
Power saving by automatically
setting temperature at 25 °C

Turbo Fan
Powerful turbo motor delivers
coolness to the room
quickly yet quietly.

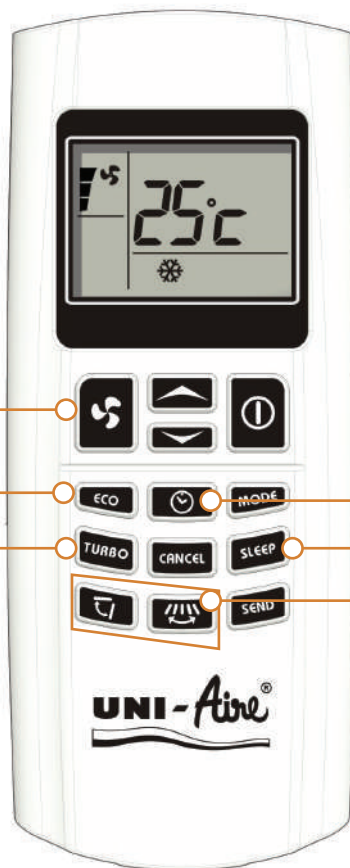

Timer On / Off
24-hour timer for turning on or
turning off the air conditioning
system

Sleep Mode
Adjust suitable temperature for
sleeping time

4 Directional airflow
Intelligent airflow system. Auto swing
louver for a better air flow, both vertical
and horizontal directions.

optional

Wired digital remote controller WIFI



With WIFI controller, multiple units in a same or different area can be operated from anywhere through internet connection



Residence



Hotel



Office

Other places



DECOR SERIES

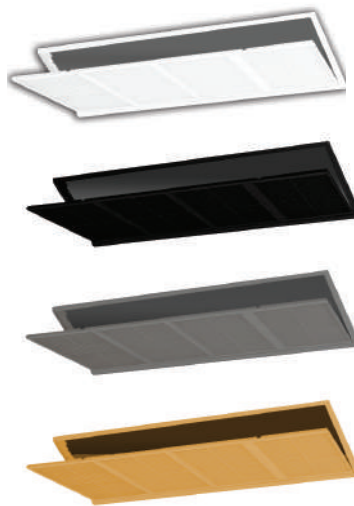
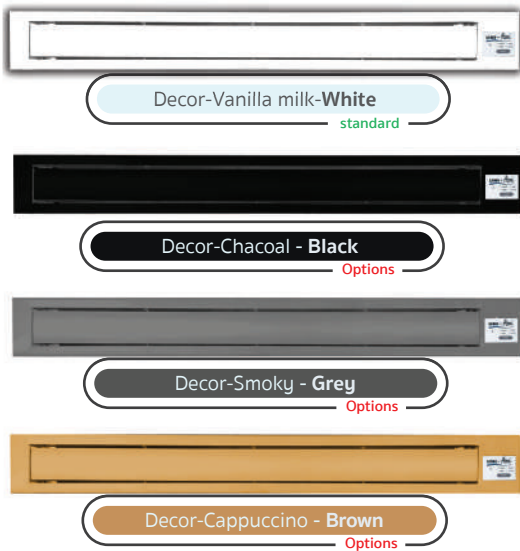

With International standard quality guaranteed by customers over 70 countries

Condensing Unit Model : AFV

Casing made from high - quality metal sheet, coated with anti - oxidation white powder coated. Durable with great heat transferred performance from advanced aerodynamic fan design. Compact size, easy installation in small space.



SPECIFICATION MODEL : CFHV / AFV , CFHQ / AFQ

Nominal Cooling Capacity (BTU/Hr)	13,454	18,562	25,105	30,936	36,153	40,077	30,691	36,296	40,562	50,000	60,000	
SEER (BTU/Hr / Watt)	12.95	13.53	13.41	12.54	12.57	12.48	12.49	12.83	12.61	11.89	11.02	
COP (Watt / Watt)	3.56	3.57	3.58	3.50	3.44	3.45	3.44	3.48	3.43	3.28	3.04	
Power Consumption (Watt)	1,096	1,485	2,067	2,600	3,081	3,478	2,645	3,046	3,499	4,488	5,780	
Rated Operation Current (Amp.)	5.18	6.83	9.53	12.60	14.49	15.45	4.82	5.44	5.75	7.94	10.09	
Power Supply (Volt/Phase/Hz)	220/1/50						380/3/50					
EGAT CERTIFIED.No.5 (มาตรฐาน เกรด 5)										-	-	
TIS Standard (มาตรฐาน สท. 2134-2553)										-	-	
TIS Standard (มาตรฐาน สท. 1529-2561)												
Fan Coil Unit	Model	CFHV-13FS	CFHV-18FS	CFHV-25F	CFHV-30F	CFHV-36F	CFHV-40F	CFHV-30F	CFHV-36F	CFHV-40F	CFHQ-50F	CFHQ-60F
	Type	Ceiling Conceal Type										
Rated Air Flow at High Speed (CFM)	450	600	800	1,000	1,200	1,400	1,000	1,200	1,400	1,600	2,000	
Fan Type	Multi Blade Centrifugal Type											
Evaporator Coil Type	Aluminium Louver Fin (Hydrophilic Coated) with Inner Grooved Copper Tube										Aluminium Louver Fin with Inner Grooved Copper Tube	
Expansion Device Type	Capillary Tube											
Control Type	Optional											
Air Filter Type	Optional											
Drain Connection (Inch)(OD)	3/4											
Dimension (W x D x H) (mm.)	1,118 x 449 x 227	1,270 x 449 x 227	1,404 x 449 x 227	1,270 x 449 x 276	1,404 x 449 x 276	1,693 x 449 x 276	1,270 x 449 x 276	1,404 x 449 x 276	1,693 x 449 x 276			
Weight (kgs.)	25	27	34	35	37	40	35	37	40	42	46	
Sound Pressure Level (dBA)	54/50/44/40	53/47/43/39	56/53/45/37	60/56/47/41	58/53/43/38	57/53/47/43	60/56/47/41	58/53/43/38	57/53/47/43	59/55/49/45	60/56/50/46	
Condensing Unit	Model	AFV-13FBS	AFV-18FBS	AFV-25FL	AFV-30FBS	AFV-36FBS	AFV-40FBS	AFV-30FBS	AFV-36FBS	AFV-40FBS	AFQ-503FX	AFQ-603FX
	Type	Horizontal Air Flow										
Fan Type	Propeller Fan											
Condenser Coil Type	Aluminium Louver Fin with Inner Grooved Copper Tube											
Compressor Type	Rotary										Scroll	
Refrigerant Type	R-32 (Fully Charge)										R-32 (Holding Charge)	
Pipe Connection	Suction Line (Inch)(OD)	1/2	5/8			3/4						
	Liquid Line (Inch)(OD)	3/8				1/2	3/8		1/2			
Dimension (W x D x H) (mm.)	804 x 330 x 530	804 x 330 x 632		944 x 380 x 784	944 x 380 x 936	944 x 380 x 1,140	944 x 380 x 784	944 x 380 x 936	944 x 380 x 1,140			
Weight (kgs.)	40	52	61	66	72	89	66	71	88	92		
Sound Pressure Level (dB(A))	53	56	58	62	62	61	62	62	61	63	65	

Remark : Cooling capacity based on 27 °C DB, 19 °C WB air on evaporator coil and 35 °C DB air on condenser.

Specifications are subjected to change without notice for future improvement.

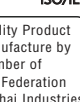

UNIAIRE CORPORATION CO., LTD.

69 Moo 3 Kingkeaw Rd., Rachatewa District, Bangplee, Samutprakarn 10540 Thailand

Tel.+662-312-4500, Email.export@uni-aire.com

www.uni-aire.com Whatsapp.+666-2312-3069